

# SCENERY LOUNGE + MODULAR // DESIGNED BY 5D STUDIO

Please note that effective April 15th, 2022, a 9% surcharge will be applied to the net subtotal on all orders.



## PRODUCT FEATURES:

- » Modular configurations comprised of lounge, love seat and sofa models in addition to corner units and benches.
- » Models with upholstered ledge along the back perimeter provide perching support as well as additional workspace choices. Ledge depth is 9", with maximum weight capacity of 275 lbs. for lounge units, and 500 lbs. for love seats and sofas.
- » Optional wood bridge is suspended between armless models with the upholstered ledge and must be specified with a bench. Bridge maximum weight capacity is 200 lbs.
- » Bench units are directional.
- » Corner units are for ganging applications only (leg formation does not allow it to stand up on its own). Ganging brackets included.
- » Refer to page 10-13 for power unit options and standard placement locations.
- » Units that require cartoning will ship KD (legs will need to be field-installed). For blanket-wrap shipments, legs will be attached.
- » All dimensions are nominal.

## MODULAR ARRANGEMENTS:

- » One ganging bracket connects two units together.
- » **Note: Please include layout drawings or sketch with order.**
- » Field assembly required.



## SPECIFICATIONS:

- » Upholstery direction must be specified on corner units when patterned fabrics are selected. In the absence of specific instructions, Arcadia reserves the right to upholster units at our discretion.

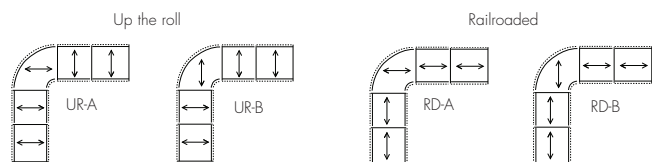

- » Wood bridge available in ash and walnut veneer, with solid wood edge on the inside perimeter and exposed plywood edge on the outside perimeter. Edge finish will match veneer finish selection.
- » For custom wood finishes, please add one-time upcharge of \$400 List per color per order.
- » Laminate bridge tops also available. Edge facing the inside is post-formed to deliver a seamless finish from the top surface to the edge underside. Edge facing the outside is exposed plywood edge.

# SCENERY LOUNGE + MODULAR // DESIGNED BY 5D STUDIO

---

## SPECIFICATIONS CONTINUED:

- » For standard wood grain laminates, exposed plywood edge will be finished to match.
- » For standard solid color laminates, exposed plywood edge will be natural (clear coat) as standard, unless otherwise specified.
- » Edges are also available in all standard wood finishes, please specify. For custom edge finishes (e.g. to match standard solid color laminates), please add one-time upcharge of \$400 List per color, per order.
- » For custom laminates, add \$500 List per color per order. Please note that selection must have post-forming capabilities. Pre-approval required, please contact client services.
- » Wood grain direction will run lengthwise.
- » Die-cast aluminum legs available in standard and premium finishes.

## STANDARD METAL LEG FINISHES:

- » #06 Charcoal Grey
- » #90 Metallic Silver
- » #92 Polished Aluminum
- » #95 Satin Black

## PREMIUM METAL LEG FINISHES:

- » #07 Gold Shimmer
- » #08 Penny
- » #09 Brown Sugar
- » #83 Metallic Champagne
- » #94 Cotton
- » #140 Oasis
- » #141 Mint
- » #142 Mercury
- » #143 Canary
- » #150 Stone

## ORDERING REQUIREMENTS:

- » Model number
- » Metal leg finish
- » Upholstery selection
- » Wood bridge finish, as applicable
- » Options, as applicable

# SCENERY LOUNGE + MODULAR // DESIGNED BY 5D STUDIO

## ORDERING REQUIREMENTS:

- » Model number
- » Upholstery selection
- » Leg finish
- » Options, as applicable

**Note: Models below cannot be ganged.**

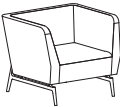
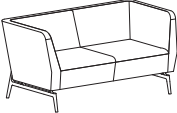
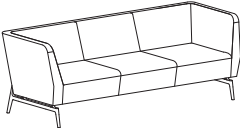

MODEL NUMBER	PRODUCT SPECIFICATIONS	FABRIC GRADES										LEATHER	
		COM	A	1	2	COL		3	4	5	6	7	8
<b>6401</b> 	<b>Lounge Chair</b> W 33 <sup>1</sup> / <sub>2</sub> D 30 <sup>1</sup> / <sub>2</sub> H 29 Seat Height 17 Inside Seat Width 20 Inside Seat Depth 22 4 <sup>1</sup> / <sub>4</sub> yds. 53 lbs. COL 85 sq. ft.	1976	2138	2244	2308	2418	2537	2644	2754	2856	2975	3485	3868
<b>6402</b> 	<b>Love Seat</b> W 57 <sup>1</sup> / <sub>2</sub> D 30 <sup>1</sup> / <sub>2</sub> H 29 Seat Height 17 Inside Seat Width 44 Inside Seat Depth 22 5 <sup>1</sup> / <sub>2</sub> yds. 73 lbs. COL 110 sq. ft.	2847	3056	3194	3276	3419	3573	3711	3854	3986	4140	4800	5295
<b>6403</b> 	<b>Sofa</b> W 81 <sup>1</sup> / <sub>2</sub> D 30 <sup>1</sup> / <sub>2</sub> H 29 Seat Height 17 Inside Seat Width 68 Inside Seat Depth 22 6 <sup>3</sup> / <sub>4</sub> yds. 95 lbs. COL 135 sq. ft.	3561	3818	3987	4088	4263	4452	4621	4797	4959	5148	5958	6565

OPTIONS		
-PF02	Premium Finish	88
-NS04	Non-Skid Glides	21

# SCENERY LOUNGE + MODULAR // DESIGNED BY 5D STUDIO

## ORDERING REQUIREMENTS:

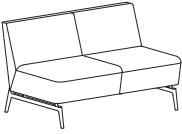
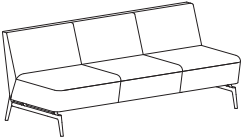
- » Model number
- » Metal leg finish
- » Upholstery selection
- » Options, as applicable

MODEL NUMBER	PRODUCT SPECIFICATIONS	FABRIC GRADES										LEATHER	
		COM	A	1	2	COL		3	4	5	6	7	8
<b>6410</b> 	<b>Armless Lounge Chair</b> W 24 D 30 <sup>1</sup> / <sub>2</sub> H 29 Seat Height 17 Inside Seat Width 24 Inside Seat Depth 22 2 <sup>3</sup> / <sub>4</sub> yds. 39 lbs. COL 45 sq. ft.	1561	1647	1703	1737	1795	1858	1915	1973	2027	2090	2360	2563
<b>6420</b> 	<b>Armless Love Seat</b> W 48 D 30 <sup>1</sup> / <sub>2</sub> H 29 Seat Height 17 Inside Seat Width 48 Inside Seat Depth 22 3 <sup>1</sup> / <sub>2</sub> yds. 60 lbs. COL 70 sq. ft.	2264	2397	2485	2537	2628	2726	2814	2905	2989	3087	3507	3822
<b>6430</b> 	<b>Armless Sofa</b> W 72 D 30 <sup>1</sup> / <sub>2</sub> H 29 Seat Height 17 Inside Seat Width 72 Inside Seat Depth 22 5 <sup>1</sup> / <sub>4</sub> yds. 82 lbs. COL 105 sq. ft.	3050	3250	3381	3460	3596	3743	3875	4011	4137	4284	4914	5387
<b>6440</b> 	<b>Corner Unit*</b> W 29 <sup>1</sup> / <sub>2</sub> D 29 <sup>1</sup> / <sub>2</sub> H 29 Seat Height 17 Inside Seat Width 22 <sup>1</sup> / <sub>4</sub> Inside Seat Depth 22 <sup>1</sup> / <sub>4</sub> 2 <sup>3</sup> / <sub>4</sub> yds. 55 lbs. COL 55 sq. ft.	1941	2046	2115	2156	2227	2304	2373	2445	2511	2588	2918	3165



\*Includes ganging connectors.

OPTIONS		
-PF02	Premium Finish	88
-NS04	Non-Skid Glides	21
GC08 (ordered separately)	Ganging Connector	80

# SCENERY LOUNGE + MODULAR // DESIGNED BY 5D STUDIO

## ORDERING REQUIREMENTS:

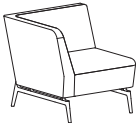
- » Model number
- » Metal leg finish
- » Upholstery selection
- » Options, as applicable



MODEL NUMBER	PRODUCT SPECIFICATIONS	FABRIC GRADES										LEATHER	
		COM	A	1	2	COL		3	4	5	6	7	8
<b>6410-R</b> 	<b>Single Seat, Right Arm as Seated</b> W 29 D 30 <sup>1</sup> / <sub>2</sub> H 29 Seat Height 17 Inside Seat Width 24 Inside Seat Depth 22 2 <sup>3</sup> / <sub>4</sub> yds. 60 lbs. COL 55 sq. ft.	1931	2036	2105	2146	2217	2294	2363	2435	2501	2578	2908	3155
<b>6410-L</b> 	<b>Single Seat, Left Arm as Seated</b> W 29 D 30 <sup>1</sup> / <sub>2</sub> H 29 Seat Height 17 Inside Seat Width 24 Inside Seat Depth 22 2 <sup>3</sup> / <sub>4</sub> yds. 60 lbs. COL 55 sq. ft.	1931	2036	2105	2146	2217	2294	2363	2435	2501	2578	2908	3155

OPTIONS		
-PF02	Premium Finish	88
-NS04	Non-Skid Glides	21
GC08 (ordered separately)	Ganging Connector	80

# SCENERY LOUNGE + MODULAR // DESIGNED BY 5D STUDIO

## ORDERING REQUIREMENTS:

- » Model number
- » Metal leg finish
- » Upholstery selection
- » Options, as applicable

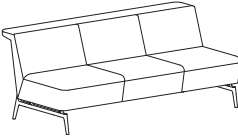
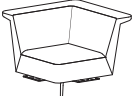
MODEL NUMBER	PRODUCT SPECIFICATIONS	FABRIC GRADES										LEATHER	
		COM	A	1	2	COL		3	4	5	6	7	8
<b>6411</b> 	<b>Armless Lounge Chair with Ledge</b> W 24 D 35 <sup>1</sup> / <sub>4</sub> H 29 Seat Height 17 Inside Seat Width 24 Inside Seat Depth 22 2 <sup>3</sup> / <sub>4</sub> yds. 42 lbs. COL 55 sq. ft.	1730	1835	1904	1945	2016	2093	2162	2234	2300	2377	2707	2954
<b>6421</b> 	<b>Armless Love Seat with Ledge</b> W 48 D 35 <sup>1</sup> / <sub>4</sub> H 29 Seat Height 17 Inside Seat Width 48 Inside Seat Depth 22 4 yds. 68 lbs. COL 80 sq. ft.	2408	2560	2660	2720	2824	2936	3036	3140	3236	3348	3828	4188
<b>6431</b> 	<b>Armless Sofa with Ledge</b> W 72 D 35 <sup>1</sup> / <sub>4</sub> H 29 Seat Height 17 Inside Seat Width 72 Inside Seat Depth 22 5 <sup>1</sup> / <sub>4</sub> yds. 94 lbs. COL 105 sq. ft.	3185	3385	3516	3595	3731	3878	4010	4146	4272	4419	5049	5522
<b>6441</b> 	<b>Corner Unit with Ledge*</b> W 35 <sup>1</sup> / <sub>4</sub> D 35 <sup>1</sup> / <sub>4</sub> H 29 Seat Height 17 Inside Seat Width 22 <sup>1</sup> / <sub>4</sub> Inside Seat Depth 22 <sup>1</sup> / <sub>4</sub> 3 <sup>3</sup> / <sub>4</sub> yds. 60 lbs. COL 75 sq. ft.	2257	2400	2494	2550	2647	2752	2846	2944	3034	3139	3589	3926

\*Includes ganging connectors.

OPTIONS		
-PF02	Premium Finish	88
-NS04	Non-Skid Glides	21
GC08 (ordered separately)	Ganging Connector	80

# SCENERY LOUNGE + MODULAR // DESIGNED BY 5D STUDIO

ORDERING REQUIREMENTS:

- » Model number
- » Metal leg finish
- » Upholstery selection
- » Options, as applicable

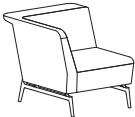
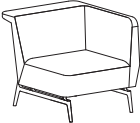

MODEL NUMBER	PRODUCT SPECIFICATIONS	FABRIC GRADES										LEATHER	
		COM	A	1	2	COL		3	4	5	6	7	8
<b>6411-R</b> 	<b>Single Seat, Right Arm as Seated</b> W 29 D 35 <sup>1</sup> / <sub>4</sub> H 29 Seat Height 17 Inside Seat Width 24 Inside Seat Depth 22 3 <sup>1</sup> / <sub>4</sub> yds. 65 lbs. COL 65 sq. ft.	2059	2183	2264	2313	2397	2488	2570	2654	2732	2823	3213	3506
<b>6411-L</b> 	<b>Single Seat, Left Arm as Seated</b> W 29 D 35 <sup>1</sup> / <sub>4</sub> H 29 Seat Height 17 Inside Seat Width 24 Inside Seat Depth 22 3 <sup>1</sup> / <sub>4</sub> yds. 65 lbs. COL 65 sq. ft.	2059	2183	2264	2313	2397	2488	2570	2654	2732	2823	3213	3506

OPTIONS		
-PF02	Premium Finish	88
-NS04	Non-Skid Glides	21
GC08 (ordered separately)	Ganging Connector	80

# SCENERY LOUNGE + MODULAR // DESIGNED BY 5D STUDIO

ORDERING REQUIREMENTS:

- » Model number
- » Upholstery selection
- » Leg finish
- » Options, as applicable
- » **Note: Bench units are directional**

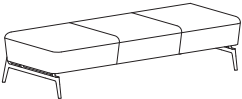
MODEL NUMBER	PRODUCT SPECIFICATIONS	FABRIC GRADES										LEATHER			
		COM	A	1	2	COL			4	5	6	7	8	L1	L2
<b>6461</b> 	<b>Single Seat Bench</b> W 24 D 30 <sup>1</sup> / <sub>2</sub> H 17 1 <sup>1</sup> / <sub>2</sub> yds. 32 lbs. COL 30 sq. ft.	1243	1300	1338	1360	1399	1441	1479	1518	1554	1596	1776	1911		
<b>6462</b> 	<b>Two-Seat Bench</b> W 48 D 30 <sup>1</sup> / <sub>2</sub> H 17 2 <sup>1</sup> / <sub>4</sub> yds. 48 lbs. COL 45 sq. ft.	1709	1795	1851	1885	1943	2006	2063	2121	2175	2238	2508	2711		
<b>6463</b> 	<b>Three-Seat Bench</b> W 72 D 30 <sup>1</sup> / <sub>2</sub> H 17 3 yds. 64 lbs. COL 60 sq. ft.	2223	2337	2412	2457	2535	2619	2694	2772	2844	2928	3288	3558		

OPTIONS		
-PF02	Premium Finish	88
-NS04	Non-Skid Glides	21
GC08 (ordered separately)	Gangng Connector	80





# SCENERY LOUNGE + MODULAR // DESIGNED BY 5D STUDIO

ORDERING REQUIREMENTS:

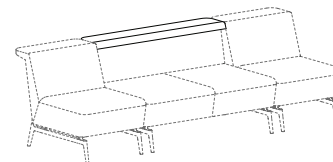
- » Model number
- » Wood species
- » Wood finish



**Note: Must be specified with bench unit for stability purposes. Please include layout drawings Include layout drawings or sketch with order**





MODEL NUMBER	PRODUCT SPECIFICATIONS	VENEER OR LAMINATE
<p><b>6448</b></p> 	<p><b>48" Wide Bridge</b>                      Depth: 9"                      Thickness: 2"</p>	<p>880</p>
<p><b>6472</b></p> 	<p><b>72" Wide Bridge</b>                      Depth: 9"                      Thickness: 2"</p>	<p>1060</p>

# SCENERY LOUNGE + MODULAR // DESIGNED BY 5D STUDIO

## ORDERING REQUIREMENTS:

- » Power unit model number should follow applicable seating model number.

**Note: No hardwire option available for this series.**

MODEL NUMBER	PRODUCT SPECIFICATIONS	LIST
<p><b>IUR-B (BLACK FINISH)</b>  <b>IUR-G (GREY FINISH)</b>  <b>IUR-W (WHITE FINISH)</b></p> 	<p><b>Integrated USB Unit</b></p> <ul style="list-style-type: none"> <li>» Dimensions: 1<sup>3</sup>/<sub>4</sub>" Diameter</li> <li>» Black, grey or white finish</li> <li>» Dual USB charging ports</li> <li>» 72" electrical cord (only length available)</li> <li>» UL listed</li> <li>» Integrated placement on seat end units or any seat back, refer to page 12 for standard locations</li> </ul>	265
<p><b>IPR-B (BLACK FINISH)</b>  <b>IPR-G (GREY FINISH)</b>  <b>IPR-W (WHITE FINISH)</b></p> 	<p><b>Integrated Power Unit</b></p> <ul style="list-style-type: none"> <li>» Dimensions: 1<sup>3</sup>/<sub>4</sub>" Diameter</li> <li>» Black, grey or white finish</li> <li>» One (1) simplex outlet</li> <li>» 72" electrical cord (only length available)</li> <li>» UL listed</li> <li>» Integrated placement on seat end units or any seat back, refer to page 12 for standard locations</li> </ul>	265
<p><b>USB1-B (BLACK FINISH)</b></p> 	<p><b>USB Charging Dock 1</b></p> <ul style="list-style-type: none"> <li>» Dimensions: 1" W x 1<sup>1</sup>/<sub>4</sub>" D x 3<sup>3</sup>/<sub>4</sub>" H</li> <li>» Black finish</li> <li>» 5V DC 2.1A (10.5 watts) USB charging port with blue LED back lighting</li> <li>» 96" electrical cord (only length available)</li> <li>» UL listed</li> <li>» Placement can be below any seating unit</li> <li>» Unit is positioned 3" from left or right edge as well as centered, please specify location (left, center or right, as seated)</li> </ul>	111
<p><b>USB2-B (BLACK FINISH)</b>  <b>USB2-W (WHITE FINISH)</b></p> 	<p><b>USB Charging Dock 2</b></p> <ul style="list-style-type: none"> <li>» Dimensions: 2<sup>1</sup>/<sub>2</sub>" W x 1<sup>1</sup>/<sub>2</sub>" D x 3<sup>3</sup>/<sub>4</sub>" H</li> <li>» Black or white finish</li> <li>» Dual 5V DC 2.1A (10.5 watts) USB charging port with blue LED back lighting</li> <li>» 96" electrical cord (only length available)</li> <li>» UL listed</li> <li>» Placement can be below any seating unit</li> <li>» Unit is positioned 3" from left or right edge as well as centered, please specify location (left, center or right, as seated)</li> </ul>	139

# SCENERY LOUNGE + MODULAR // DESIGNED BY 5D STUDIO

## ORDERING REQUIREMENTS:

- » Power unit model number should follow applicable seating model number.

**Note: No hardwire option available for this series.**

MODEL NUMBER	PRODUCT SPECIFICATIONS	LIST
<p><b>MT1-B (BLACK FINISH)</b> <b>MT1-W (WHITE FINISH)</b></p>	<p><b>Mini-Tap 1</b></p> <ul style="list-style-type: none"> <li>» Dimensions: 3" W x 3" D x 1<sup>3</sup>/<sub>4</sub>" H</li> <li>» Black or white finish</li> <li>» One (1) simplex outlet and two (2) USB charging ports</li> <li>» 72" electrical cord (only length available)</li> <li>» UL listed</li> <li>» Placement can be below any seating unit</li> <li>» Unit is positioned 3" from left or right edge as well as centered, please specify location (left, center or right, as seated)</li> </ul>	<p>331</p>
<p><b>MT2-B (BLACK FINISH)</b> <b>MT2-W (WHITE FINISH)</b></p>	<p><b>Mini-Tap 2</b></p> <ul style="list-style-type: none"> <li>» Dimensions: 3" W x 3" D x 1<sup>3</sup>/<sub>4</sub>" H</li> <li>» Black or white finish</li> <li>» Two (2) simplex outlets</li> <li>» 72" electrical cord (only length available)</li> <li>» Placement can be below any seating unit</li> <li>» Unit is positioned 3" from left or right edge as well as centered, please specify location (left, center or right, as seated)</li> </ul>	<p>304</p>

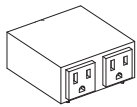
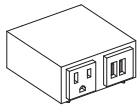

# SCENERY LOUNGE + MODULAR // DESIGNED BY 5D STUDIO

## STANDARD POWER UNIT LOCATIONS:

» For Integrated USB and Integrated Power units, standard placement is as follows:

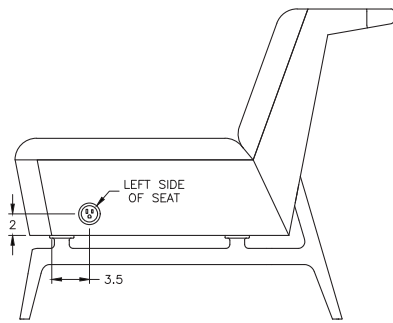

Side placement (armless models only)

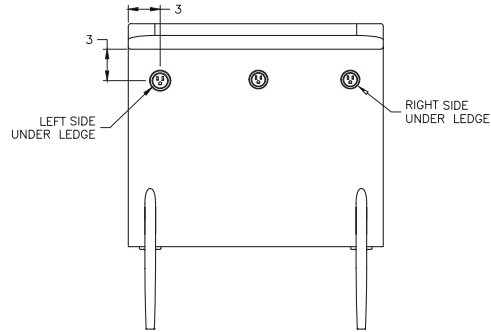

Back placement - specify left, center\* or right, as facing back

\*Center position not available on love seat models

# SCENERY LOUNGE + MODULAR // DESIGNED BY 5D STUDIO

## CONFIGURATION EXAMPLES:

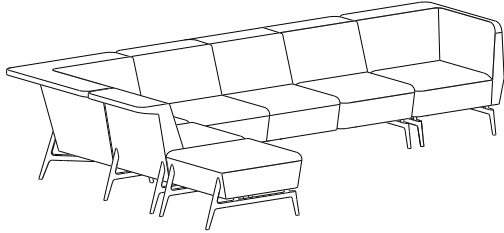

Qty	Model #	Description	COM List
1	6461	Single Seat Bench	\$1,243
1	6411	Armless Lounge Chair with Ledge	\$1,730
1	6441	Corner Unit with Ledge	\$2,257
1	6431	Armless Sofa with Ledge	\$3,185
1	6411-L	Single Seat, Left Arm	\$2,059
			<b>\$10,474</b>

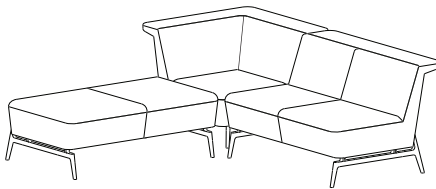

Qty	Model #	Description	COM List
1	6462	Two-Seat Bench	\$1,709
1	6441	Corner Unit with Ledge	\$2,257
1	6421	Armless Love Seat with Ledge	\$2,408
			<b>\$6,374</b>

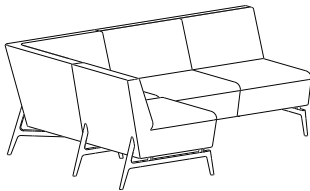

Qty	Model #	Description	COM List
1	6410	Armless Lounge Chair	\$1,561
1	6440	Corner Unit	\$1,941
1	6420	Armless Love Seat	\$2,264
			<b>\$5,766</b>

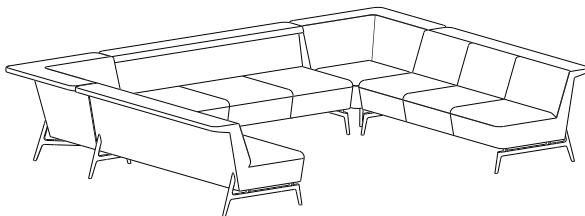

Qty	Model #	Description	COM List
2	6431	Armless Sofa with Ledge (\$3,185 each)	\$6,370
2	6441	Corner Unit with Ledge (\$2,257 each)	\$4,514
1	6472	72" Wide Wood Bridge	\$1,060
1	6463	Three-Seat Bench	\$2,223
			<b>\$14,167</b>

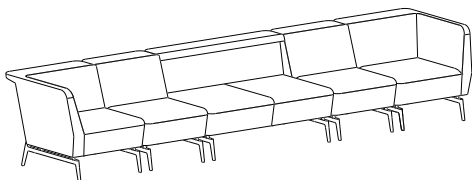

Qty	Model #	Description	COM List
1	6411-R	Single Seat, Right Arm	\$2,059
2	6411	Armless Lounge Chair with Ledge (\$1,730each)	\$3,460
1	6448	48" Wide Wood Bridge	\$880
1	6462	Two-Seat Bench	\$1,709
1	6411-L	Single Seat, Left Arm	\$2,059
			<b>\$10,167</b>

Note: Scenery ganging connectors not included in pricing examples as shown above.

# SCENERY LOUNGE + MODULAR // DESIGNED BY 5D STUDIO

## UPHOLSTERY COMBINATIONS:

- » When combining two COM/COV/COL fabrics, or fabrics with the same grade, add \$95 List per unit.
- » When combining different grades of fabric, price will be based on the highest grade specified.
- » Two-tone upholstery examples and yardage requirements for the most common combinations are listed below. Additional combinations available, please contact client services for yardage requirements and pricing.
- » Note: Yardage amounts are based on fabric which is plain (i.e. non-directional) and a full 54" wide.
- » Appropriate upholstery code must be included.



**Code** SC1  
**Model** 6401  
**COM Requirement**  
 Seat Cushion Only = 1 yd.  
 Balance of Unit = 3<sup>1</sup>/<sub>2</sub> yds.

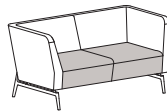

**Code** SC2  
**Model** 6402  
**COM Requirement**  
 Seat Cushion Only = 1<sup>1</sup>/<sub>2</sub> yds.  
 Balance of Unit = 4<sup>1</sup>/<sub>4</sub> yds.

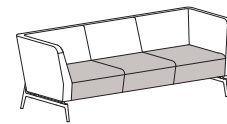

**Code** SC3  
**Model** 6403  
**COM Requirement**  
 Seat Cushion Only = 2<sup>1</sup>/<sub>4</sub> yds.  
 Balance of Unit = 4<sup>3</sup>/<sub>4</sub> yds.



**Code** SC4  
**Model** 6410  
**COM Requirement**  
 Seat Cushion = 1<sup>1</sup>/<sub>4</sub> yds.  
 Back Cushion = 1<sup>1</sup>/<sub>4</sub> yds.



**Code** SC5  
**Model** 6420  
**COM Requirement**  
 Seat Cushion Only = 1<sup>1</sup>/<sub>2</sub> yds.  
 Balance of Unit = 2<sup>1</sup>/<sub>4</sub> yds.

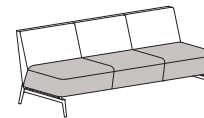

**Code** SC6  
**Model** 6430  
**COM Requirement**  
 Seat Cushion Only = 2<sup>1</sup>/<sub>2</sub> yds.  
 Balance of Unit = 2<sup>3</sup>/<sub>4</sub> yds.



**Code** SC7  
**Model** 6440  
**COM Requirement**  
 Seat Cushion = 1 yd.  
 Back Cushion = 2<sup>1</sup>/<sub>2</sub> yds.



**Code** SC8  
**Model** 6410-R  
 6410-L  
**COM Requirement**  
 Seat Cushion Only = 1 yd.  
 Balance of Unit = 2<sup>1</sup>/<sub>2</sub> yds.



**Code** SC9  
**Model** 6411  
**COM Requirement**  
 Seat Cushion Only = 1<sup>1</sup>/<sub>4</sub> yds.  
 Balance of Unit = 1<sup>3</sup>/<sub>4</sub> yds.

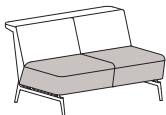

**Code** SC10  
**Model** 6421  
**COM Requirement**  
 Seat Cushion = 1<sup>1</sup>/<sub>2</sub> yds.  
 Back Cushion = 2<sup>3</sup>/<sub>4</sub> yds.

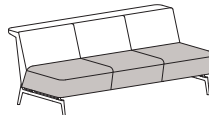

**Code** SC11  
**Model** 6431  
**COM Requirement**  
 Seat Cushion Only = 2<sup>1</sup>/<sub>2</sub> yds.  
 Balance of Unit = 3<sup>3</sup>/<sub>4</sub> yds.



**Code** SC12  
**Model** 6441  
**COM Requirement**  
 Seat Cushion Only = 1 yd.  
 Balance of Unit = 3<sup>1</sup>/<sub>2</sub> yds.



**Code** SC13  
**Model** 6411-R  
 6411-L  
**COM Requirement**  
 Seat Cushion Only = 1 yd.  
 Balance of Unit = 2<sup>3</sup>/<sub>4</sub> yds.